



***GE Power Generation***

---

# **Gas Turbine Inlet Air Treatment**

**R.L. Loud**  
Engineer, Gas Turbine  
Power Plant Systems  
and  
**A.A. Slaterpryce**  
Manager, Gas Turbine  
Power Plant Systems

**GE Company**  
Schenectady, New York



# GAS TURBINE INLET AIR TREATMENT

**RL. Loud**                      **and**                      **A.A. Slaterpryce**  
**Engineer, Gas Turbine**                      **Manager, Gas Turbine**  
**Power Plant Systems**  
**General Elect& Company**  
**Schenectady, NY**

## CONTENTS

	Page
Introduction .....	1
<b>Air Filtration</b> .....	<b>1</b>
Anti-Icing Systems .....	15
Inlet Cooling Systems .....	18
Summary .....	<b>22</b>
References .....	<b>22</b>

*A Table Conversion Factors is included at the end of this publication.*

## INTRODUCTION

Gas turbines manufactured by General Electric Company are operating successfully in rural areas and heavy industrial zones, in polar regions and the tropics, in deserts and at sea. In order to adapt machines to a variety of environments while realizing their full potential in performance and reliability, it is often necessary to treat the air which they consume. Even in relatively clean environments, a gas turbine may ingest hundreds of pounds of foreign matter each year. Whether or not this will cause a problem depends on the amount of this material, its mechanical properties, and its chemical composition. The hazards of nonremoval include erosion of compressor and turbine components, fouling of compressor airfoils, and corrosion. Solid particles are removed by appropriate filters, while potentially corrosive liquids are removed by moisture separators.

In warmer climates, the power available from a gas turbine may be increased by using an evaporative cooler or a chilled water cooling system. Conversely, in very cold environments it is necessary to avoid icing of components such as inlet filtration and the trash screen, silencers, and inlet guide vanes.

This paper will discuss in detail the environmental conditions that indicate need for inlet air treatment, the specific equipment utilized by **General Electric** to perform these functions, and their impact on gas turbine operation.

## AIR FILTRATION

### Need for Filtration

Any gas turbine, due to its inherent design and the enormous amount of air consumed (e.g. 1296 lb/s or 587 kg/s for the **MS9001F**), is sensitive to air quality. Filtration is applied to provide protection against the effects of contaminated air that may degrade gas turbine performance and life: erosion, fouling, corrosion, and cooling passage plugging. The need for proper filtration has increased in significance due to the complex designs of the advanced technology **7F** and **9F** machines.

### Erosion

Both the axial compressor and the **hot-gas-path** parts can be affected by erosion from hard, abrasive particles, such as sand and mineral dusts.

As these particles impact upon the compressor blades, they cut away a small amount of metal. The net rate of erosion, although 'not precisely quantifiable, depends on the kinetic energy change as the particles impinge, on the number of particles impinging per unit time, the angle of impingement, and on the mechanical properties of both the particles and the material being eroded.

In general, our gas turbine experience indicates that particles below **10µm** do not cause erosion, whereas particles **20µm** and above normally cause erosion when present in sufficient quantities.

Two examples of eroded parts, a compressor blade and a first-stage nozzle, are shown in Figs. 1 and 2. Not only does erosion reduce aerodynamic performance, but the reduction in cross-sectional area of the compressor blade could lead to serious turbine damage if, because of increased local stresses, it should break loose during operation. Air filtration methods are available which can easily and very efficiently remove airborne particles of **10µm** and above.

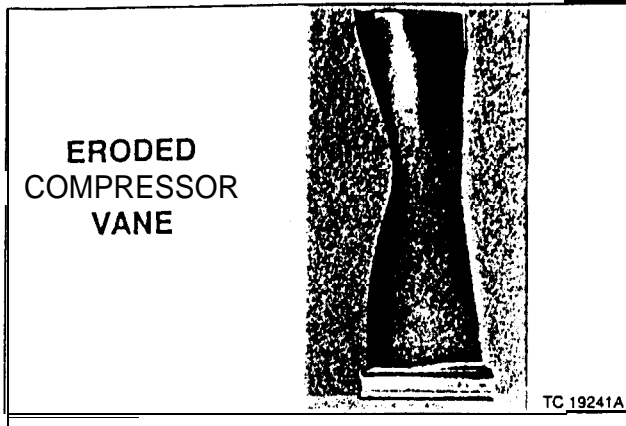

Figure 1

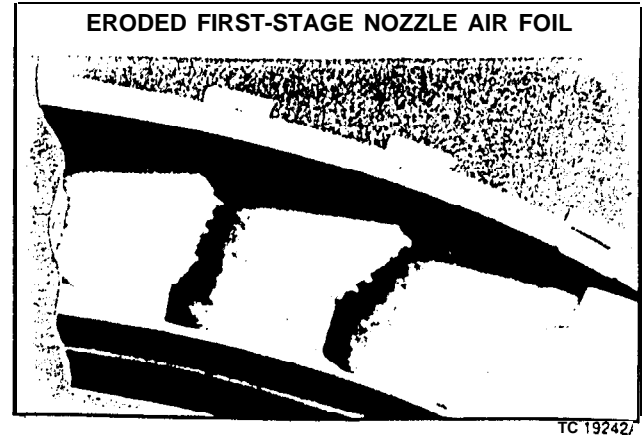

Figure 2

### Compressor Fouling

The efficiency of an axial compressor is dependent on, among other considerations, the smoothness of the rotating and stationary blade surfaces. These surfaces can be roughened by erosion, but more frequently roughening is caused by the ingestion of substances which adhere to the surfaces. These include oil vapors, smoke, and sea salt. Figure 3 shows deposits formed on the leading edge of rotating blades. The output of a turbine can be reduced as much as 20 percent in cases of extreme compressor fouling. The rate at which this fouling takes place is difficult to quantify because it depends not only on the types and quantities of materials ingested, but also on the peculiar properties of the substances that cause them to stick. Filtration can remove some, but not all, of these substances. Certain vapors that are adhesive when they condense can pass through filters. Other vapors may originate between the filter and the compressor, such as occasional lubricating oil leaks.

Fortunately, today there are ways of removing these adhesive deposits from the compressor

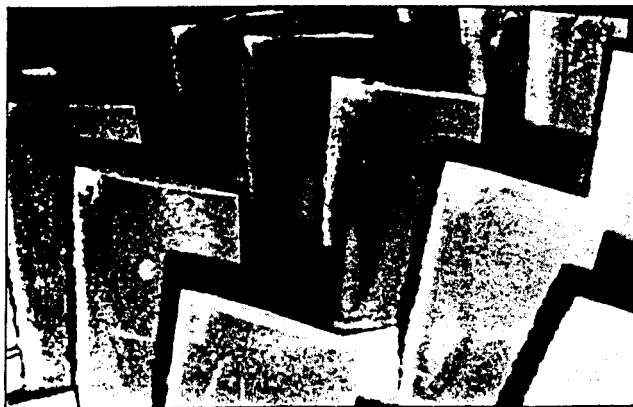

Figure 3

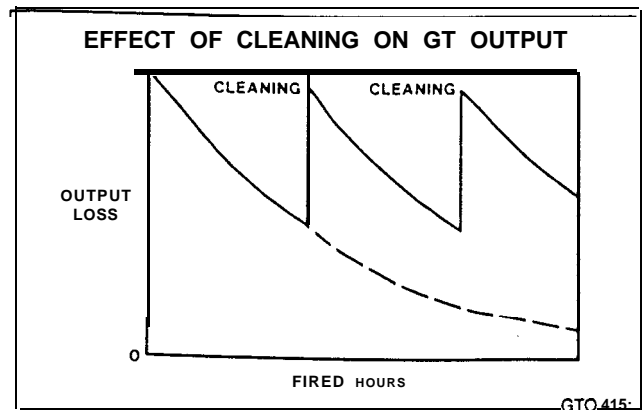

Figure 4

applied during turbine operation. Specific water wash chemical recommendations are contained in **GEI-41042**.

Figure 4 shows the effect of compressor cleaning on gas turbine output. It shows that output deteriorates along a decaying exponential curve as the compressor continues to foul. Removal of the fouling deposits restores gas turbine output to nearly the original value.

### Compressor Corrosion

Corrosion of compressor components can be caused by wet deposits of sea salt, acids, and other deleterious materials. In addition to rusting of compressor wheels, such corrosion is also manifested as pitting of the compressor blading. Pitting causes a roughening of the airfoils with consequent reduction in the aerodynamic performance of the compressor. These pits also cause local stress risers and may diminish the fatigue life of the blades. In addition to filtration, protective coatings for both blading and wheels have been very effective where environments are known to contain corrosive compounds.

### Hot-Section Corrosion

Possibly the single most important and frequently encountered consequence of inadequate air filtration has to do with the ingestion of certain metals which, after combining with sulfur and/or oxygen during the combustion process, deposit on the surfaces of the hot gas path parts. These parts include combustion liners, transition pieces, nozzle partitions and turbine buckets. There are four such metals which are of primary concern: sodium (Na), potassium (K), vanadium (V) and lead (Pb). These metals, either as sulfates or oxides, cause the normally protective oxide film on **hot-gas-path** parts to be disrupted so that the parts oxidize several times faster than in the presence of gases free of them.<sup>13</sup> They may be found in fuels and in water or steam, as well as in the inlet air. Allowable limits are set forth in **GEI-41047**. The effects of these contaminants on the turbine are also discussed in this reference. The following relationship may be used to calculate the limits in the inlet air:

$$\frac{(A)}{(F)} X_A + \frac{(S)}{(F)} X_S + X_F$$

Equivalent contaminants in fuel alone

where

$$\frac{(A)}{(F)} = \text{Air-to-fuel mass flow ratio}$$

$$\frac{(S)}{(F)} = \text{Steam-to-fuel mass flow ratio}$$

$X_F$  = Contaminant concentration (weight) in fuel (ppm)

$X_A$  = Contaminant concentration (weight) in inlet air (ppm)

$X_S$  = Contaminant concentration (weight) in injected steam/water (ppm)

When concentrations of trace metals in fuel, water, or steam are not precisely known, a limit for these contaminants in the inlet air of 0.005 ppm will normally be set. This limit, based on experience, would cause an insignificant contribution to the overall contaminant level and have a minor effect on parts lives. Reference should be made to the appropriate fuel specification for guidance.

### Cooling Passage Plugging

Flow of cooling air through passages in the combustion liner, nozzles, and buckets is necessary to control metal temperatures of these parts. Since the cooling flow is extracted from the compressor of the gas turbine, contaminants in the inlet air may also be present in the cooling air. If these contaminants cause a buildup in the cooling passages, heat transfer is degraded and temperatures may increase to levels which give rise to cracking. This is especially critical in the advanced technology "**F**" machines which, because of their higher firing temperatures, require a very complex system of cooling passages. **Coal** dust, cement dust, and fly ash are particularly bad, since they tend to sinter.

### Environments

Ambient air can be contaminated by solids, liquids, or gases. Of these three, contamination by solids is the most common, and usually the most serious situation. The quantity of solids can be defined in many ways, such as milligrams per cubic meter of air or grains per 1000 cubic feet. **A measure** General Electric finds convenient is parts per million (ppm), i.e., the mass of contaminants per million units mass of air. The fact that this is a convenient measure immediately demonstrates that the quantity of dust is generally quite small compared to the mass of air. However, when account is taken of the **large** flow rates of gas turbines, it is evident that the total quantity of dust which is ingested can be **appreciable** when summed over hundreds or thousands of fired hours.

In the United States, the Environmental Protection Agency samples airborne particulates periodically at some 4000 locations. Results of the annual surveys are published, giving an excellent idea of the statistical variation of dust loading at the test sites.<sup>4</sup> The typical range of values is shown in Fig. 5. Curve A gives the percentage of U.S. sites exceeding a given dust load 50 percent of the time; curve B shows the percentage of test locations exceeding a particular dust load 10 percent of the time. These curves show that the typical dust concentration in most locations is from about 0.03 to 0.06 ppm, with occasional excursions at some sites to 0.2 or 0.3 ppm. It must be understood that particular locations may deviate significantly from these typical values. While the curves are derived only from U.S. data, similar values are to be expected in other developed countries having temperate climates.

Dust loading in desert regions, particularly those subject to sand and dust storms, is much higher than those usually experienced in the United States. Concentrations in sand storms may reach several hundred ppm for periods of

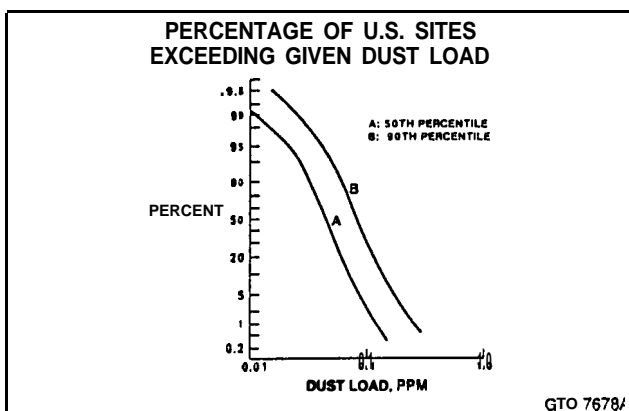

Figure 5

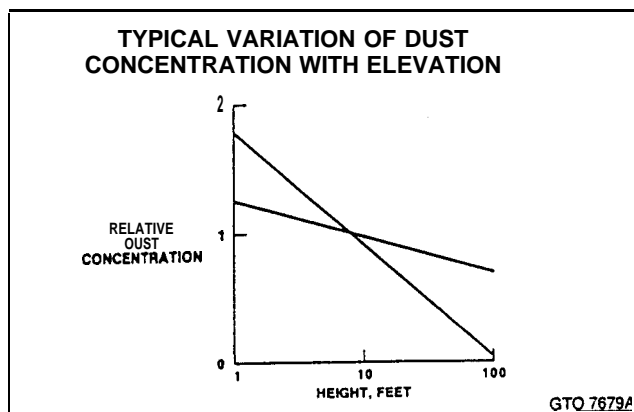

Figure 6

several hours, while long-term levels may average one to five ppm. When the wind blows in these regions, the larger soil particles become airborne first, smaller particles being more adherent. When the large particles fall back to earth, they disturb the surface and "splash out" fine particles. By Stokes' law, fine particles settle more slowly; so they remain airborne longer. The results are that the dust concentration is highest close to the ground, and that the particles there tend to be coarser than at higher elevations. There is no exact relationship between dust concentration and elevation above ground, but available data generally tend to fall within the range of Fig. 6. This shows that elevating a filter compartment some 20 ft. in the air approximately halves the dust load, compared to a ground-mounted compartment.

The size distributions of airborne dusts are variable with respect to time and place. In general, high values of dust concentration tend to be associated with coarse dust and low values with fine dust. Large dust particles tend to fall out quickly, while smaller particles are more likely to stay airborne. Consequently, dust samples taken near the source of contamination tend to be coarser than those samples taken at a distance.

Some idea of the size distributions experienced in practice can be had by reference to the standardized dusts, Arizona Coarse and Arizona Fine, which are widely used in the testing of air filtration devices. Table 1 shows their mass distribution as a function of particle size. Since the

**Table 1**  
**Components of Arizona Road Dust**

Particle Size Range (microns)	Nominal Percentage of Total Mass of Particles	
	Course Dust	Fine Dust
0-5	12	39
5-10	12	18
10-20	14	16
20-40	23	18
40-80	30	9
80-200	9	

mass of a particle is proportional to the cube of its diameter, it will be recognized that typical dusts have many fine particles, and relatively few particles of large diameter.

The chemical composition of airborne dusts is significant, particularly with regard to sodium and potassium, which contribute to hot corrosion. General Electric has analyzed many dust samples from around the world. Typically, it is found that airborne dust has about twice as much of these elements as do local soils. This apparent anomaly arises because the fine particles of soil tend to be richest in sodium and potassium, and these particles stay suspended in the air while larger particles fall back to earth. Airborne dusts from different locations vary widely in their composition, depending partly on local soils and partly on industrial pollutants released into the air. In general, the most corrosive dusts come from desert regions in which the soil is a former seabed. Sodium and potassium may make up as much as 5 percent of the weight in extreme cases. Values of 1 to 3 percent are more typical. As an example, suppose that the long-term average dust load at a desert site is 3 ppm, and that the dust is 2 percent sodium plus potassium. The corrosive content of the dust is therefore  $3 \times 0.02 = 0.06$  ppm. Assuming a typical air/fuel mass ratio of 50:1, this is equivalent to  $50 \times 0.06 = 3$  ppm sodium plus potassium in the fuel. This is excessive and indicates that inlet air filtration would be required.

### Equipment Description

Equipment designed by General Electric to filter the inlet air can be divided into two classes, conventional and self cleaning. Conventional filters include inertial separators and media-type filters; the latter are normally replaced when they become dirty. **Self-cleaning** filters, introduced in the 1970s, have become well accepted and now account for 80 to 90% of the new systems sold by General Electric. These are media-type filters which have the ability to renew themselves by automatically shedding accumulated dust

An important characteristic of an air filter is its collection efficiency, calculated from the weight of dust entering and leaving:

$$\text{Efficiency} = \frac{W_{\text{entering}} - W_{\text{leaving}}}{W_{\text{entering}}} \times 100 \text{ (percent)}$$

Collection efficiency varies with particle size, typically being lower for small particles than for large.

### High-Efficiency Filters

High efficiency filters use a special filter medium of fiberglass or treated paper to achieve good collection efficiency for all particles, including those as small as  $1 \mu\text{m}$ . Figure 7 shows typical efficiency as a function of particle size. Because the collection efficiency is very high, the air quality downstream is also high, even when the ambient air is badly contaminated.

High efficiency filters generally take the form of either a rectangular panel filter or a cylindrical cartridge filter. Other than their shape, the two major differences are in the type of media used and the design of the seal where the element is attached.

The panel filters typically contain a depth loading media. Particles are actually trapped within the body of the media itself. Depth loading media has a billowy texture which allows the particles to penetrate. Cylindrical cartridge filters contain a surface loading media. This traps the particles on the outside face where they form a dust layer. This dust layer actually enhances the collection efficiency of the filter causing it to become more efficient with time. It is the surface loading characteristic that allows the dust to be dislodged during cleaning.

The seal on the filter element is another area of prime importance. There is no point in providing filters of such high efficiency if contaminated air is continually leaking past them. It is here that the cylindrical cartridge has a distinct advantage over the rectangular panel. Cylindrical cartridges have a continuous, circular, neoprene gasket permanently affixed to each element. This gasket is capable of making up for variations in the mating surface. Panel filters have various types of sealing mechanisms available, but none have shown to be as reliable as the cylindrical cartridge seal.

Rectangular panel filters are available as a replaceable element which is held in shape by a

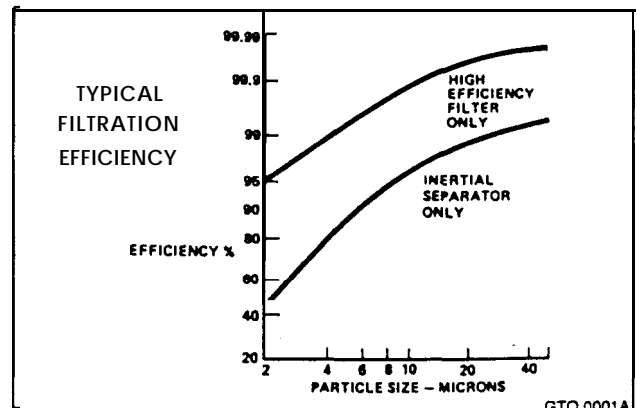

Figure 7

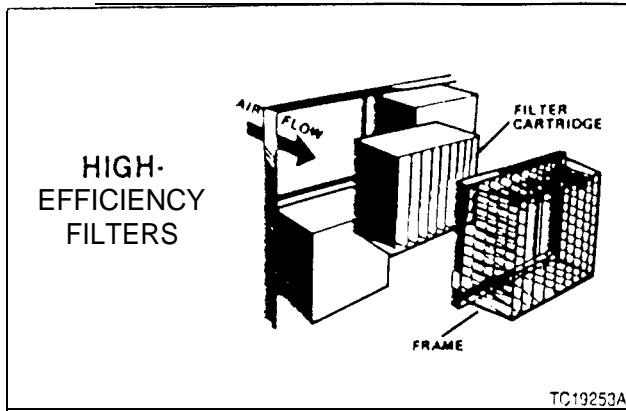

Figure 8

wire frame, Fig. 8, or as an integral assembly with the media bonded to a metal frame, Fig. 9. Cylindrical cartridge filters are also integral assemblies incorporating the frame and media into a single unit, Fig. 10.

High-efficiency filters have an initial pressure drop which depends upon their construction, installation, and on the quantity of air passed through each filter element. Filters normally use pleated media in order to increase the available surface area; this decreases pressure drop and increases dust-holding capacity. As dust is accumulated, pressure drop rises. The rise is relatively slow at first, but increases more rapidly as the filter nears the end of its useful life. A typical design would have a new-and-clean pressure drop of about an inch of water; the final pressure drop depends upon a trade-off between filter life and gas turbine performance. General Electric recommends a final pressure drop of 2.5 in. as a good compromise for panel filters and 4.0 in. for cylindrical cartridges.

The dust-holding capacity of a filter is an important characteristic, since it relates to filter life. Dust holding capacity is not easy to define,

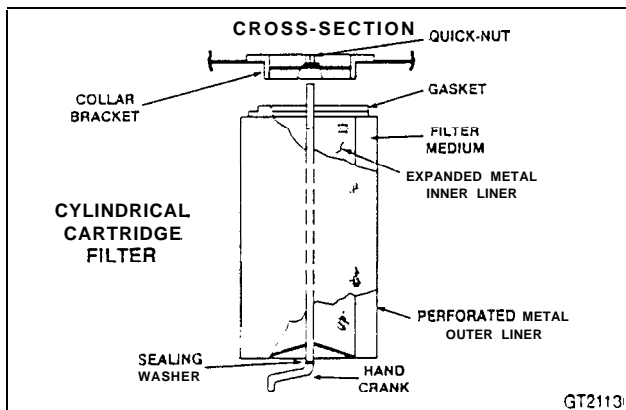

Figure 10

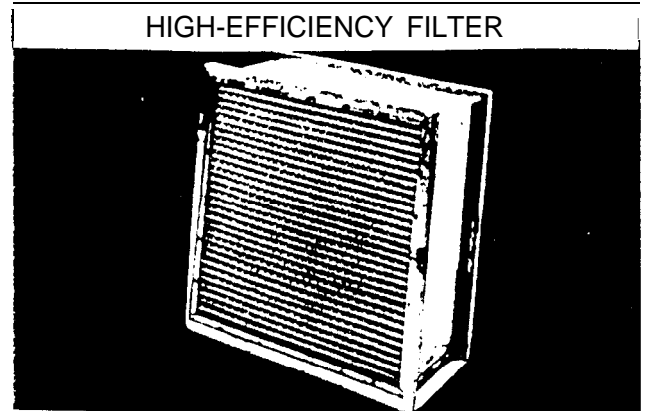

Figure 9

since it depends upon the particle size distribution of the incident dust. For a given pressure drop, a filter can hold a greater mass of large particles than of small particles. Therefore, a filter will "load up" more quickly with fine dust than with the same amount of sand. Filter manufacturers commonly use Arizona Fine test dust to rate high-efficiency filters. This is reasonable, since it provides a conservative rating which is valid even in environments where larger particles may not be present in the ambient air.

### Self-Cleaning Filters

Self-cleaning inlet filtration, developed in the 1970s, combines the effectiveness of the high-efficiency filter with low maintenance. This combination of characteristics is realized by using a barrier-type filter element which accumulates dust on the surface which is exposed to the ambient air. The collection efficiency is typical of high-efficiency filters. When pressure drop builds up to a predetermined level, the filter is cleaned by a brief back-pulse of air, either extracted from the gas turbine compressor, or

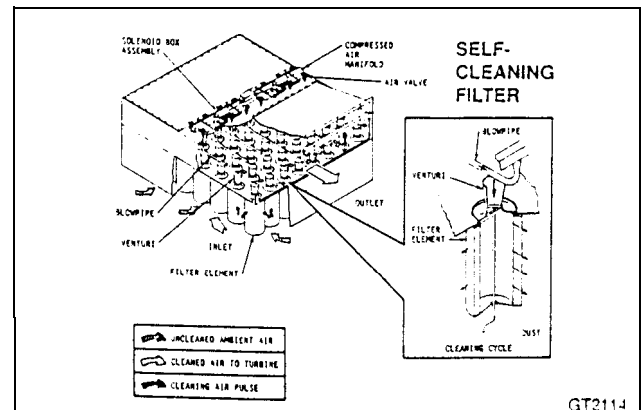

Figure 11



derived from an auxiliary source. A filter compartment includes many filter elements, only a few of which are cleaned at any given time; so the airflow to the gas turbine is not disturbed by the cleaning process.

The action of a **self-cleaning** filter is illustrated in Fig. 11. Air flows through the filter elements into a clean-air plenum. Dust in the air is trapped on the surface of the filter media, which is formed from specially treated cellulose, synthetic, or combination cellulose/synthetic **filter** paper. The filter elements are typically in the form of cylindrical cartridges. The paper is pleated in order to increase the available **surface** area. Many filter elements are used so that the velocity of the air through the filter media is very low, in the range of 2.5 to **3 ft/min**. This low velocity decreases pressure drop, increases dust-holding capacity, and is essential to the cleanability of the filters.

As the filters accumulate dust, the pressure drop gradually rises. When the pressure in the clean-air plenum reaches a particular value, usually set at 3 to 4 in. of water, gauge, cleaning is initiated. A cleaning manifold is pressurized nominally to 100 psig with compressed air, extracted from the gas turbine compressor or some other suitable source. Upon command from the automatic sequencing control, a solenoid-operated air valve directs a brief (about 0.1 s) pulse of air into the filters. This shocks and causes a momentary **backflow** through the **filters**, dislodging accumulated dust from the outside of the elements and allowing it to disperse. **Re-entrainment** of dust is minimized by the **low-velocity** design. The updraft and between filter velocities are kept at or below 320 and 580 feet per minute respectively. The process continues, cleaning a few filters at a time, until all elements have been cleaned and pressure drop reduced to an acceptable level. A single cleaning cycle is usually completed in 20 to 30 minutes. This ensures that the compartment can handle heavy dust loads, such as those associated with sandstorms, without excessive rise in pressure drop.

The filter elements are replaced when they begin to show signs of deterioration caused by heat and ultraviolet rays from the sun, or when the cleaning cycle can no longer restore pressure drop. While this period cannot be quantified for all environments, experience indicates about a two-year life in Middle-East deserts. However, filter life may be **substantially** lower in extremely harsh environments such as those heavily laden with airborne cement dust. About 100 man-hours are required for complete filter **changeout** for an MS7001 gas turbine.

**Figure 12** shows a typical self-cleaning compartment installed on an MS6001 gas turbine. It

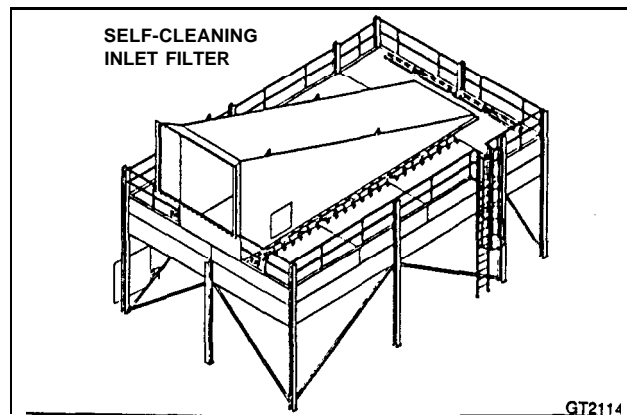

Figure 12

includes several hundred filter elements, mounted in modules which feed into a tapered **clean-air** plenum. Each module has the filter elements enclosed by a metal skirt, which protects them from damage. The upward velocity of air into self-cleaning modules is low, so the module acts as its own weather hood. In order to reduce the compartment footprint, the modules may be arranged in two or more tiers. The lower tier of modules acts as the platform for access to the upper tier. Walkways, ladders, and railings are provided as necessary for safe access. Since access to the clean air plenum is infrequently required, a bolt-on hatch is provided instead of a door. There is a convenience outlet to aid interior inspections and **maintenance**. A differential pressure gauge/pressure switch is supplied to read plenum pressure, and control the operation of the self cleaning system. Alarms are provided for excessive differential pressure in the plenum and for low pressure in the pulse cleaning air supply. Pressure switches are also provided to initiate a controlled shutdown in the event that differential pressure in the plenum becomes dangerously high.

### Cartridge Type, Non-Self Cleaning Filters

In environments where the concentration of airborne contaminants or other considerations make it impractical to pulse clean inlet filters, the high efficiency **self-cleaning type** cylindrical **cartridges** may still be used. Such a system can be identical in configuration to the self-cleaning compartment with the exception that the **pulsing** hardware is omitted.

This system acts as a static barrier filter while maintaining many of the advantages of the self cleaning system. Such advantages include high dust holding capacity, positive sealing **mecha-**

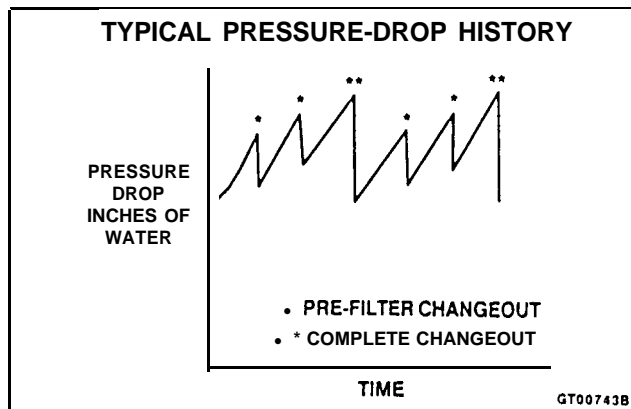

Figure 13

nism, inherent low velocities and low pressure drop. The dust holding capacity of a single cylindrical self-cleaning **type** cartridge filter is on the order of 2500 grams for Arizona Fine dust. Dust holding capacities for high efficiency panel filters are in the range of 400 to 700 grams of dust.

### Prefilters

If the ambient dust load is fairly high, as in some industrial areas, it may be economical to further protect the high-efficiency filters by means of inexpensive, disposable media-type **pre**-filters. The mounting frames for the prefilters are typically placed directly in front of the high-efficiency filters which they protect. Figure 13 illustrates how the pressure drop of the entire filter system typically varies with time. Three prefilter changeouts are shown for each change of **high**-efficiency filters, which is a common experience.

A typical two-stage filter system (prefilters and high-efficiency filters) can remove several hundred pounds of dust from the gas turbine inlet air before the high-efficiency filters must be replaced. It is not possible to predict specific results based on average filter life because each site is unique; however, 5000 to 7000 fired hours is typical of two-stage systems in the United States. Without prefilters, the life would be decreased by a factor of two or more.

### Inertial Separator

Air containing dust, dirt, and chemical contaminants enter the open end of a V-shaped pocket (Fig. 14). The ends of the pocket are solid, with both sides made up of louvered slots. The dirt is separated from the air as the air turns to pass through the open slots in the sides and the larger dirt particles continue in a straight line to a collection chute aided by a bleed fan. The bleed rate is approximately 10

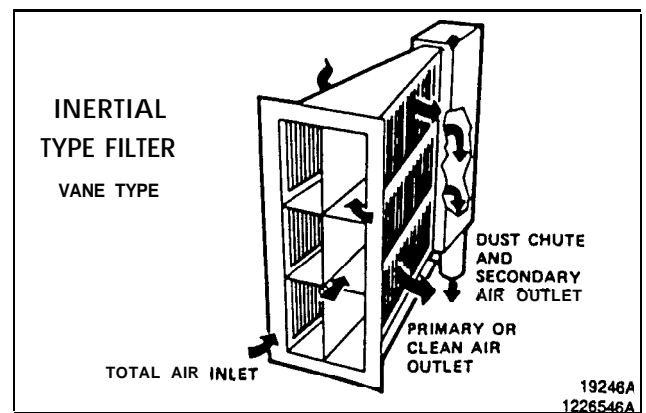

Figure 14

percent of the primary flow. This system must be in operation while the turbine is running to ensure the collection of particles.

Another **type** of inertial separator is the **spin**-type, shown in Fig. 15. The incoming air/dust mixture is given a spin by the stationary inlet centrifugal blades, thereby causing the heavier particles to collect near the surface of the outer tube, where they are scavenged by a bleed **fan** system. The clean air is drawn through the center tube and then on into the gas turbine. Spin tubes **typi**cally require more frontal area than van-type separators, which may sometimes preclude their use.

While the arrangements of vane-type and spin-type inertial separators are different, operationally they have much in common. Separation efficiency rises rapidly at first as flow through the separator increases; it then reaches a broad plateau where higher flow has relatively small effect on efficiency. Since increasing flow leads to higher pressure drop, which lowers the performance of the gas turbine, the design engineer must balance separator cost and performance against gas turbine performance when deciding the appropriate design point. The

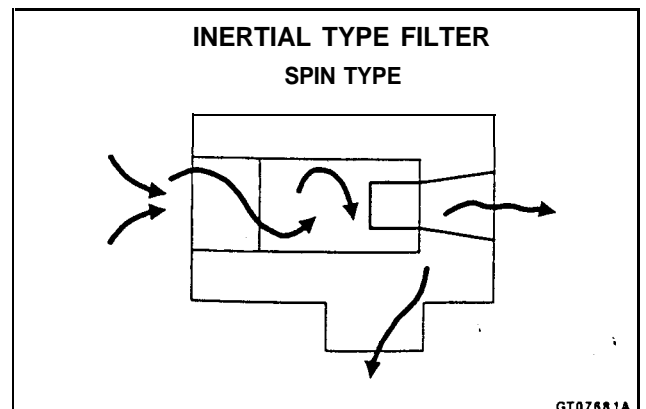

Figure 15

usual choice is the point at which high collection efficiency is combined with acceptable pressure drop, typically 1.0 to 1.5 in. of water.

The bottom curve of Fig. 7 shows typical separation efficiency as a function of particle size. Since the performance of an inertial separator is excellent for particles larger than  $10\mu\text{m}$ , this provides a defense against the compressor erosion described previously. It is also effective against corrosion if the corrosive particles are in the **greater-than- $10\mu\text{m}$**  size range.

Generally, inertial separators which, in a sense are selfcleaning by design, are used as the first stage of filtration, preceding high-efficiency filters. In this case, they extend the life of the high-efficiency filters by removing some of the dust which would otherwise cause them to foul.

## Weather Protection

In cold climates, ingestion of large quantities of snow or **freezing** rain can cause icing of inlet components. This can adversely affect performance of filtration equipment, and may result in physical damage to the inlet duct or the gas turbine compressor. In warmer climates, prolonged downpours may overload inertial separators, allowing water to be transmitted downstream. If there are no high-efficiency filters, this will not be harmful. If there are high efficiency filters, prolonged wetting will increase the pressure drop and weaken the filter media structure. **For** these reasons, certain applications may require that the air filters be preceded by weather protection.

Weather protection, when required, is usually provided by means of an inlet hood, such as shown in Fig. 16, or weather louvers. Louvers may be subject to icing under winter conditions. Hoods do not have this problem, and have demonstrated their suitability in both tropical and arctic climates. Weather hoods achieve rejection of precipitation by drawing inlet air

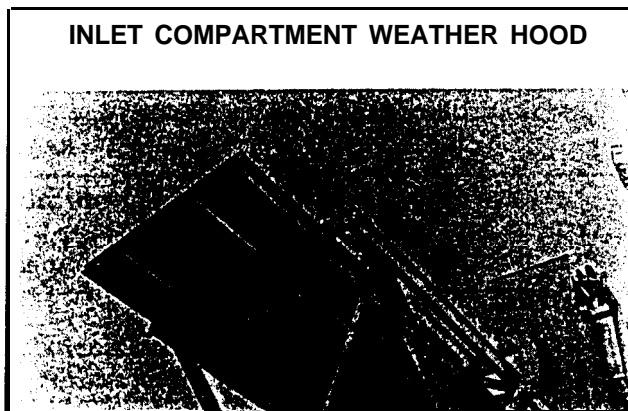

GT06807

Figure 16

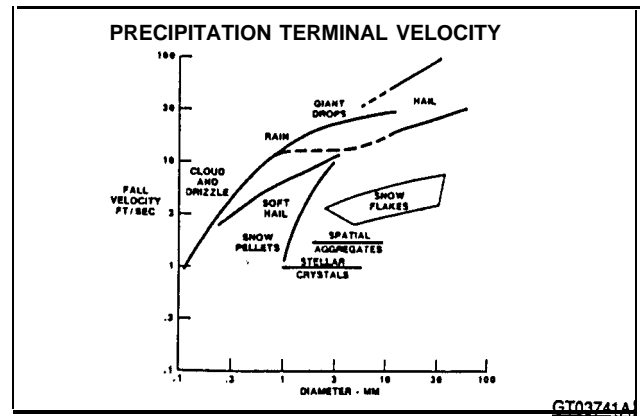
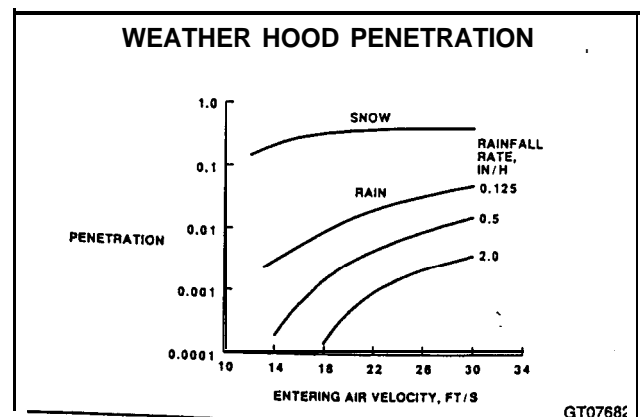

Figure 17

upward at low velocity, thereby discriminating against the snow or rain which is falling downward at some terminal velocity. The terminal velocities of different forms of precipitation vary widely (Fig. 17), and it is intuitively evident that a given hood design will be more effective in rejecting fast-falling raindrops than slow-falling snowflakes. In order to quantify this, a modeling study was conducted on the computer, taking into account not only the geometry of the hood and its associated flow field, but also such factors as the drop-size distributions in rainstorms of various intensities, Figure 18 gives the rejection efficiency of single hoods as a function of face velocity and rainfall rate. A curve is also given for typical snow rejection. It is clear from these results that a high degree of rain rejection is available from hoods of moderate size, but that large hoods are required to reject snow.

## Inlet Filter Compartments

Inlet filter compartments are normally elevated in General Electric designs. If only inertial separators are used, this improves air quali-



GT07682

Figure 18

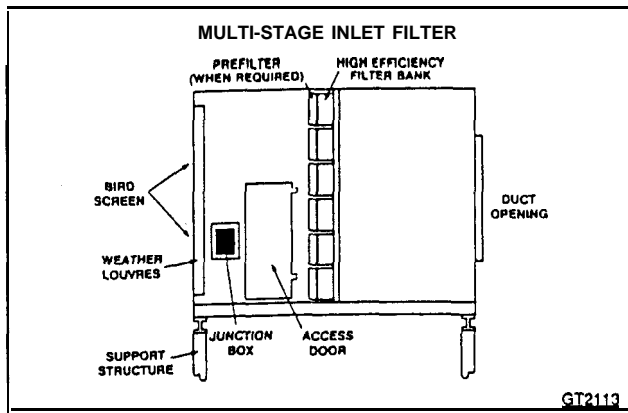

**Figure 19**

ty entering the gas turbine; if the compartment uses high-efficiency filters, elevation prolongs the filter life. A typical arrangement of an inlet filter compartment using conventional components is shown in Fig. 19. The entering air first encounters a bird screen, then the weather louvres. The access door is just downstream of the weather louvres. Entry is via a caged ladder and service platform. The compartment includes interior lighting and convenience outlets, and a junction box for electri-

cal power. An alarm is provided to indicate that the pressure drop of the inlet filters is excessive. If corrective action is not taken and pressure drop rises further, pressure switches will automatically initiate an orderly shutdown of the gas turbine. The alarm is a signal to stop and service wornout filters.

Inlet compartments are typically fabricated from 3/16 in. steel plate to provide a rigid structure capable of withstanding severe environmental loadings. Guides for these loadings are the Uniform Building Code and ANSI A58.1. A wind force contour of 40 lb./ft.<sup>2</sup>, Zone 4 seismic loads, and 40 lb./ft.<sup>2</sup> snow loads (as defined by these authorities) are used as design criteria. Allowable stress levels are taken from the AISC Steel Construction Manual. The standard finish is inorganic zinc primer with a high build epoxy intermediate coat inside and out. The epoxy serves as a final coat for the inside while the external surface will require a final coat after installation.

Because of their size, inlet compartments are usually shipped in several subassemblies. These are seal welded in the field to form the complete structure. Inlet compartments are normally elevated in order to avoid ground-level pollutants.

**Table 2**  
**Classification of Ambient Air Quality**

Air Quality	Location	Land Use	Description
Clean	Rural	Recreation	Undeveloped land Moderate rain No extended dry season Continuous ground cover Light traffic
	Suburban/Urban	Residential	Mainly single or multiple dwellings Paved roads, light to moderate traffic
Dusty	Rural	Agriculture	Dust-producing activities such as plowing and harvesting
	Urban	Commercial or Industrial	Stores, warehouses, trucking, mining construction, manufacturing
Contaminated	Seacoast	Any	Less than 10 miles from salt water
	Dry Lake	Any	Former seabed in area of low rainfall
	Urban	Industrial	Corrosive elements in dust, such as chemicals, cement, and coal-fired boilers Also includes areas subject to smoke and fumes
Desert	Rural	Agriculture	Dust from chemical fertilizers
	Arid Lands	Any	Little or no rain, extended dry periods Winds sometimes cause sand or dust storms with limited (cl mile) visibility

## Recommended Inlet Air Filtration

Design of a system to adequately protect the gas turbine requires knowledge of ambient air quality and establishment of criteria for inlet air quality; the ratio between them defines the required filter efficiency. Trade-offs can be made between first cost, maintenance cost, and gas turbine performance. The following guide has taken these concerns into account, and gives recommendations for heavy-duty gas turbines in nonmarine applications.

Table 2 can be used to classify ambient air quality at a particular gas turbine site as either clean, dusty, contaminated, or desert. When making judgments, consideration should be taken of possible future land use as well as current conditions. The gas turbine itself will have negligible impact on the quality of the air at the site, but other associated site developments may have an effect. This is particularly true when the gas turbine is to be part of a larger process or system.

Recommended inlet air filtration can be related to air quality through the use of Table 3.

Self cleaning filters are the standard filtration means for General Electric heavy-duty gas turbines. If passive filters are required, prefilters are also recommended if the ambient dust load is moderately high (> 0.1 ppm by weight), based upon economic studies which show that this is to the user's benefit.

In addition to the filters described in Table 3, other devices are needed to supplement conventional filters in special situations. Insect screens may be required in subarctic, subtropical, and tropical locations subject to insect swarms. The user often provides this equipment. Weather

**Table 3**  
**Recommended Filtration**

Environment	Filtration		
	Prefilters	High Efficiency	
		Passive	Self Cleaning
Clean		X	
Dusty	X	X	
			X
Contaminated	X	X	
			X
Desert			X

protection is recommended on all units with high efficiency filtration. Protection can be in the form of weather hoods and/or rain louvres. The self cleaning system is inherently protected by the skirts that extend to a few inches below the bottom of the filter cartridges.

For several reasons, General Electric does not recommend that standard, conventional inlet filter compartments be entered when the gas turbine is operating, or that high-efficiency filters be serviced under this condition. First, the pressure drop of the weather louvres appears across the compartment access door, holding it closed with a force of about 120 lbs., although because of the relative positions of the 'hinges and the latch, only about 60 lbs. pull is required to break the door free. Second, the pressure drop of the dirty high-efficiency filters tends to hold them in place against their mounts with a force of about 50 lbs., which must be overcome by the service crew, who may be working several feet above the floor. Third, the filters should be released and removed in such a way that they do not dump dust back into the airstream, and this may not be possible if the crew does not have special training and supervision.

Compartments with conventional media-type filters can be designed with special features to alleviate these problems. However, in most cases self-cleaning filter compartments offer a solution that is technically and operationally more satisfactory, and less expensive. General Electric recommends the use of self-cleaning filters for all applications where site conditions require the use of high-efficiency filters and where the life of these filters is projected to be shorter than the interval during which continuous operation is required.

In regions subject to sand and dust storms, such as deserts of North Africa and the Middle East, most users find it extremely burdensome to properly maintain conventional media-type filters because dust loads may become high at unpredictable times, resulting in very rapid filter consumption. Unless large supplies of spares and a changeout crew are available at the site, the frequent result is that the gas turbine operates for a period with the implosion door open, ingesting unfiltered air during a time when filtration is needed the most or the protective pressure switches simply initiate a shutdown and the turbine is taken out of service. Self-cleaning filters should be used in this type of environment because they overcome these problems. The self-cleaning function permits continuous operation during storm conditions without operator attention. Filter life is relatively inde-

pendent of ambient dust loading; experience indicates that two years is typical. Consequently, filter maintenance can be combined with other scheduled maintenance in order to increase availability. The fact that self-cleaning filters have longer life in the desert than conventional designs reduces overall maintenance costs. A major user of gas turbines in Saudi Arabia has reported that conventional systems cost three times as much as selfcleaning for replacement filters and associated labor for changeouts

In cases where there is a question as to the most appropriate inlet air filtration, General Electric should be consulted. Site information and operating experience are available for many specific locations, worldwide. Where data are lacking, various services are available to acquire and analyze ambient air quality and then to prepare recommendations.

## AIR FILTRATION IN MARINE ENVIRONMENTS

### The Marine Environment

Coastal, marine, and off-shore platform installations present unique problems of inlet air contamination, as salt from seawater can become airborne in **significant** quantity due to wind and wave action. As discussed earlier, this can give rise to corrosion. The sodium concentration at any given time and place is a function of many factors, including elevation, wave height, wind velocity, temperature, humidity, and the previous history of the local air mass.

The salt content of air above or near the sea can be thought of as being from two sources: the fine droplets ejected from bursting bubbles, and the relatively coarse spray from whitecaps and breaking waves. These two effects are to a degree

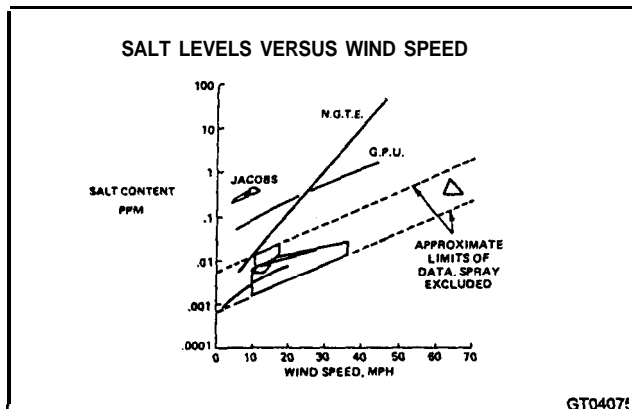

Figure 20

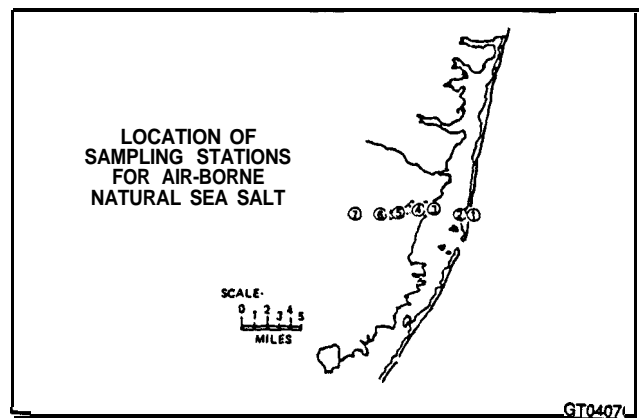

Figure 21

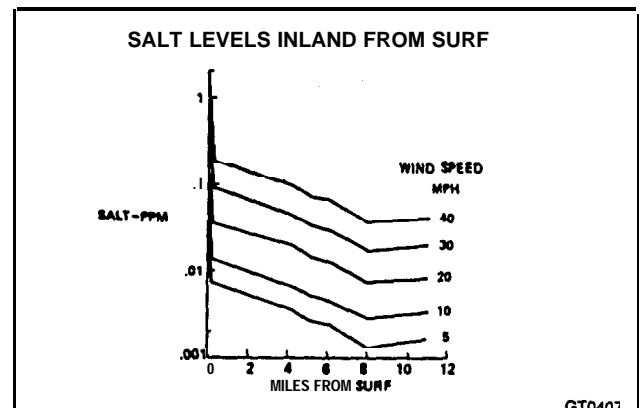

Figure 22

separable; they can be evaluated by comparing the salt content of aerosols in which spray was excluded, and those in which it was not

Figure 20 contains data from many different investigators showing salt concentration as a function of wind speed. The data within the dotted lines were recorded during test conditions in which there was some effort to eliminate spray effects. Some of the uncertainty arises from the fact that salt particles can be transmitted over long distances by the wind; local wind speeds may not be typical of those at the location where the particles were generated.

If the gas turbine intake is subject to salt spray, as from surf, whitecaps, or the bow-wave of a ship, the situation can become much more severe. The measurements by National Gas Turbine Establishment (NGTE), Jacobs, and GPU Service Co. are in poor agreement, demonstrating that salt ingestion from spray can vary over wide limits depending upon wind speed, wind direction, elevation, distance from surf, and **self-generation** (as by a ship).

The measurements by GPU Service Co. are interesting in that they include data at a number

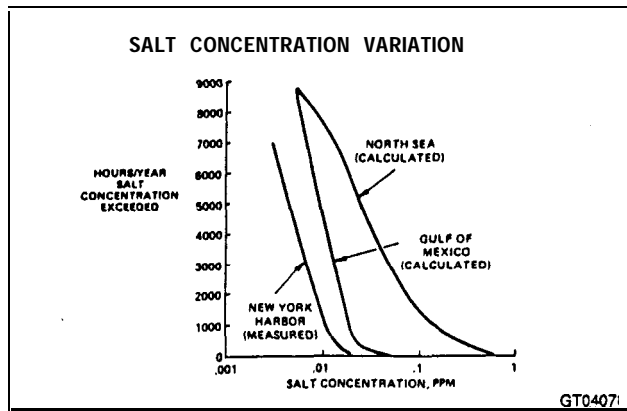

Figure 23

of stations at different distances from the surf line. As a result, this information can be used to estimate the **dropoff** in salt concentration in on-shore applications in coastal regions. Fig. 21 is a map showing the measurement locations. Station 1 was on the seaward side of a sandy barrier beach. (It is Station 1 data which are shown in Fig. 20). Station 2 was on the land side of the barrier beach or the seaward side of the bay, about a quarter mile from the surf. Station 3 was on the land side of the bay, while subsequent measuring points were farther inland.

Figure 22 shows data taken during on-shore winds, plotted in such a way as to emphasize the rate of decay of salt level with distance. It is obvious that an order-of-magnitude drop is experienced in going from the surf line to the leeward side of the barrier beach; it can be assumed that this is due to the fall-out of spray generated by the waves. If the data from the lee side of the barrier beach are compared to the salt levels shown in Fig. 20, it is seen that they fall very close to the dashed line representing the upper limit of the **nonspray** data, confirming the assumption that these data are essentially free of spray effects. The next measuring station, some 4.25 miles from the surf, on the land side of the bay, has salt levels falling well within the limit lines of Fig. 20. Salt levels continue to decay with distance up to a range of eight miles; the data at eleven miles show a small increase for reasons which are not explained. It is probable that the data at eight to eleven miles are approaching the natural background level due to non-marine sources. This supposition is supported by the fact that the median sodium level in the ambient air as measured by General Electric at 41 domestic gas turbine sites—mostly far inland—was 0.0026 ppm, which is equivalent to 0.008 ppm sea salt.

If the statistical variation of wind velocity at a site is known, Fig. 20 can be used to estimate the

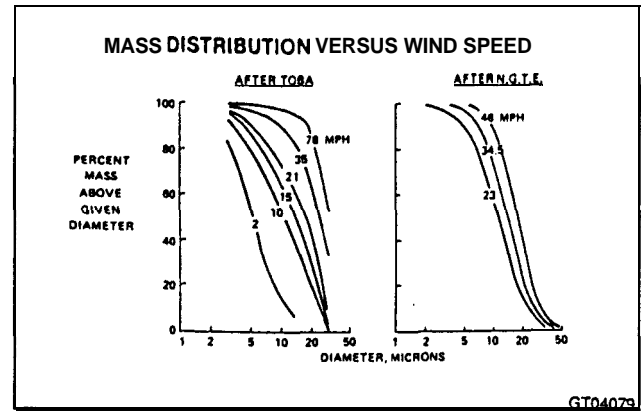

Figure 24

salt content of the ambient air. The hours per year that a given salt level is likely to be exceeded in the North Sea and the Gulf of Mexico has been predicted (Fig. 23). The dashed upper limit of salt concentration (without spray effects) was used in this calculation. Figure 23 also includes and interpretation of data on sodium levels measured at 30 ft. elevation during winter months in The Narrows, at the entrance to New York Harbor.\* Salt levels have been deduced by assuming that the contaminants were 32 percent sodium, as is typical of sea salt. The measured salt levels are about half those predicted for the Gulf of Mexico, which as a similar wind velocity distribution. When one considers that winds in this protected harbor will often come **from** over land rather than water, this seems reasonable agreement.

The size distribution of marine aerosols as a function of wind velocity can be estimated from Fig. 24, which is based upon data published by Toba<sup>9</sup> and by the National Gas Turbine Establishment.<sup>10</sup> The two references show variations in detail, but similar trends. Part of the difference lies in the **difficulty** of the measurements, but there are also differences in the philosophy of the studies. Toba combined theory and experiment to define the environment over the open ocean, while the NGTE information is based upon shipboard studies. In each case as wind velocity increases, the droplet size distribution skews toward the larger sizes. Therefore, wind speed will generally determine the concentration and size distribution of the particles.

Whether salt particles will exist as dry crystals or saturated droplets will depend primarily on the relative humidity. If the salt particles start out as **droplets**, as they will at the high humidity present at the water/air boundary, they will remain as supersaturated droplets until the relative humidity falls to 45 percent or **less**.<sup>11</sup> This is probably due to the presence of highly soluble magnesium and

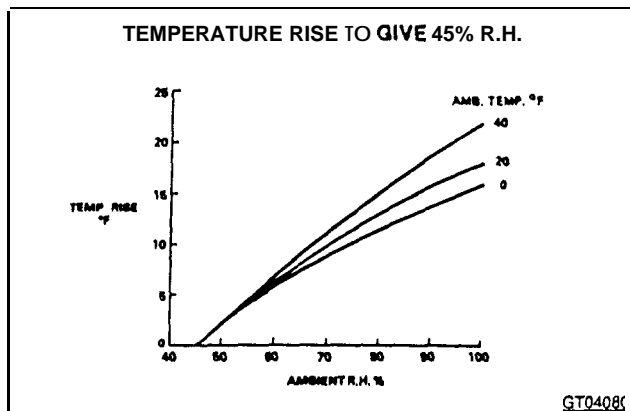

Figure 25

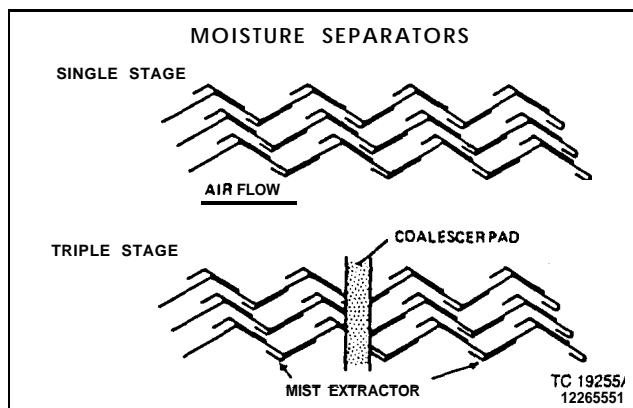

Figure 26

calcium chlorides. Conversely, once the salt is in crystalline form, it will not deliquesce until the relative humidity rises to about 73 percent.

Since relative humidity in maritime air very rarely falls below 45 percent, salt will almost always be present in droplet form. The exception to this could be gas turbine installations using anti-icing systems to heat the inlet air. Under the assumption that the inlet heating system adds negligible moisture to the air, Fig. 25 shows the temperature rise required to decrease relative humidity to 45 percent as a function of ambient conditions. If the inlet heating schedule has a temperature rise equal to or greater than that defined by the appropriate curve, the relative humidity of the heated air will drop to such levels that salt will exist as dry crystals.

### Equipment for Salt Removal

Several manufacturers offer equipment suitable for the removal of liquid salt from the incoming air stream. The majority of these systems operate on the same physical mechanism and differ only in materials and design details.

Most are available either as single- or three-stage systems, the use of which depends on the environment expected (Fig. 26). Single-stage systems typically consist of a series of vertically oriented hooked vanes mounted parallel to the airflow. These vanes impose several direction changes to the incoming air. Entrained droplets impinge upon the sides of the vanes, being unable to follow the air path due to their greater mass. The effectiveness of such a system is proportional to the velocity of the air stream and thus to the momentum of the droplets. After impingement the droplet migrates along the surface of the vane until a hook is encountered. The solution migrating to the hooks flows down along the hooks to a catch through and drain located below the separator.

A three-stage system typically consists of a first-stage vane as described above, followed by a coalescer pad and a second vane stage. The coalescer pad is typically a nonwoven pad approximately 1 in. thick, made from polyester or similar material. This pad functions to capture smaller droplets that were not removed in the first stage of the separator. After capture these droplets may either drain down through the pad to the catch through below or agglomerate with other droplets to form larger droplets which become re-entrained in the air stream. These agglomerated droplets are captured by the last stage of vanes, which is typically identical to the first stage.

Figure 27 shows salt penetration through typical single-stage and three-stage moisture separators as a function of windspeed. These penetration curves can be computed by combining moisture separator collection efficiencies with the particle size distribution curves of Fig. 24 and the overall salt content as a function of wind velocity from Fig. 20. Toba's particle size distribution curves and the dashed upper limit curve from Fig. 20 were used for these particular calculations.

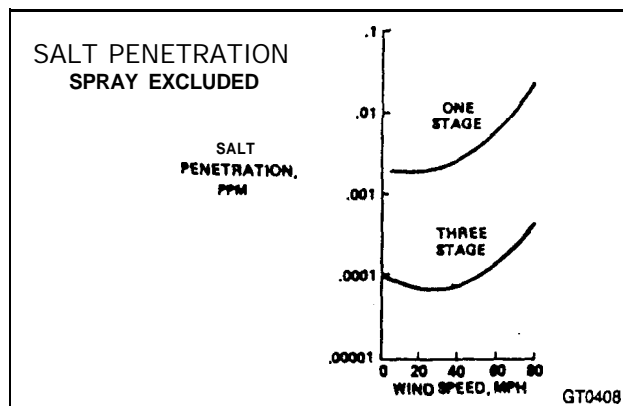

Figure 27



**Table 4**  
**Experience with High-Velocity Moisture**  
**Separators on GE**  
**Heavy-Duty Gas Turbines**

Application	Moisture Separator	
	One-Stage	Three-Stage
Ships	2	12
Platforms, North Sea		45
Platforms, Gulf of Mexico	2	5
Platforms, Arabian Gulf	9	-
Others		2

### Experience

Over 75 General Electric heavy-duty gas turbines equipped with single- or three-stage high-velocity moisture separators have been installed on platforms, ships, or coastal sites.<sup>12</sup> These applications are summarized in Table 4.

Several of the platform and ship turbines have accumulated over 40,000 fired hours with the original buckets and nozzles. Successful operation is based on the following conditions:

- The number of stages in the moisture separator is a function of the allowable salt ingestion criteria and the expected wind velocities at the site. North Sea sites have statistically higher wind velocities than Gulf of Mexico sites and therefore require three stages instead of one.
- The moisture separators, particularly the **coalescer** pads, must be protected from drilling mud and cement, sandblasting material, and, in some locations, duststorms. This will prevent frequent changeout of the **coalescers** due to plugging from these materials. Prefilters upstream of the separators may be necessary to remove these contaminants.
- Liquid seals on the separator drains must be maintained so that drainage water will not be drawn into the compartment downstream of the separators.

Turbines at coastal locations have generally been far enough from the surf line that salt

spray and droplets are not encountered. High-efficiency filters were used to remove salt crystals from the inlet air.

## ANTI-ICING SYSTEMS

### Introduction

The operation of gas turbines in cold climates presents certain unique problems, one of which is inlet icing. Icing can block inlet filtration equipment, causing the gas turbine to ingest unfiltered air or shut down. It can increase the pressure drop across trash screens and other inlet components, leading to performance loss and possible damage to ductwork from implosive forces. In extreme cases, ice can build up on inlet bellmouths, with hazard of foreign-object damage and compressor surge. Anti-icing systems are designed to inhibit ice formation on inlet components in order to protect the gas turbine from these effects and to allow it to operate reliably in the icing environment.

### Icing Phenomena

Precipitate icing occurs when water is ingested as a liquid or solid at temperatures near or below freezing, with wet snow and freezing rain being obvious examples. If the precipitation remains suspended in the air-stream, it causes no special problems. However, ice will adhere strongly to most surfaces, and buildup can be a particular problem if the temperature is near freezing.<sup>13</sup>

If a body of air cools at relatively constant moisture content, a point is reached at which the vapor condenses, forming water droplets. This is the dew point. Further depression of the temperature results in super-cooling of the droplets. This condition is unstable, so that when droplets contact an inlet surface, rapid buildup of **hoarfrost** results. In typical air masses, with many condensation nuclei present, suspended droplets remain liquid until about **-22°F**.<sup>14</sup>

When fuels are burned, both heat and water vapor are released into the atmosphere. The heat tends to reduce relative humidity (**RH**), while the water vapor tends to increase it. Typically, the burning of fuel tends to reduce **RH** when ambient temperatures are warmer than about **-20°F**. **When** colder than about **-30°F**, the burning of fuel increases **RH**. Between these limits, a calculation (which includes initial **RH**) is required to predict the effect. If weather conditions inhibit mixing of the air, an increase in **RH** can give rise to the arctic phenomenon

known as ice fog, in which the atmosphere is supersaturated with respect to ice.<sup>14</sup>

While icing generally occurs on the first obstacle encountered by air entering an inlet system, typically a trash screen or a filter, it is possible for ice to form on the inlet bellmouth of the gas turbine without forming on other upstream components. This phenomenon is explained by the isentropic acceleration of the air as it enters the bellmouth, which results in cooling. While much of this temperature depression is recovered at surfaces such as the bearing support struts or inlet guide vanes, these surfaces can still be several degrees cooler than ambient. The calculated wall temperature depression at the inlet guide vanes of the LM2500 is 3.5°F, while the corresponding value for heavy-duty machines is 2.4°F. This temperature depression can cause local icing in the bellmouth if the air is sufficiently moist. Ice formation in the bellmouth could reduce the surge margin of the compressor, and if chunks of ice break off and enter the engine, foreign object damage may occur. Heavy-duty gas turbines are more tolerant of the bellmouth icing than are aircraft-derivative engines due to their lesser temperature depression, heavier compressor blading, and greater surge margin.

### Protective Features

Inlet systems for cold climates are designed to protect the gas turbine from damage due to icing and to keep the machine running with minimum effect on performance. Typical designs include self cleaning filters which can remove ice in much the same way that they remove dust, an inlet heating system to inhibit ice formation downstream of the filters, and protective devices to prevent damage in the event of system malfunction or operation outside the normal design envelope. These features are illustrated in Fig. 28 which shows the side elevation of an inlet system.

The anti-icing module contains the inlet heating manifold, which introduces warm air downstream of the self cleaning filters in the inlet duct. If there is icing on the inlet filters, a pressure switch which senses increasing pressure drop, initiates the self cleaning system. An alarm is signalled if pressure drop continues to increase. If no action is taken by the operator, a gas turbine shutdown is signalled by the inlet protective pressure switches. The split trash screen in the inlet duct protects against ingestion of ice as well as trash. Its design is such that it can pass air without excessive pressure drop,

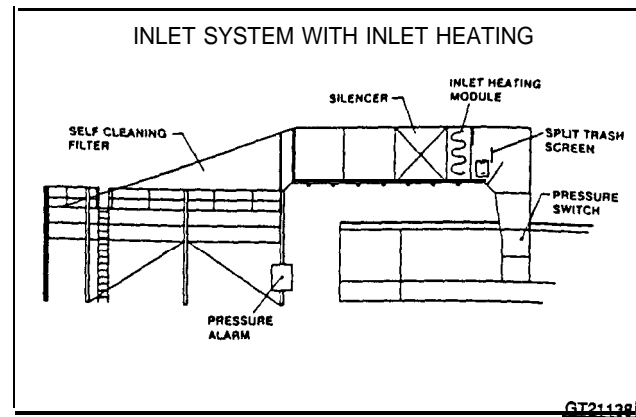

Figure 28

even if the screen ices because of cold air being drawn through any leaks in the ductwork. Finally, another pressure alarm can be located in the inlet plenum. If desired, this switch can be used to initiate a controlled shutdown when the pressure drop of the total inlet system reaches a predetermined level.

Ingestion of snow and freezing rain into the inlet should be minimized in order to make the job of the anti-icing system easier, particularly in the near-freezing temperature range. One way that this is done is by elevating the inlet filter compartment. Studies show that the flux of blowing snow drops by a factor of about 5 when going from an elevation of 5 to 25 ft.<sup>15</sup> There is little benefit in further elevation because wind-driven snow tends to be concentrated near ground level. Ingestion of rain and snow is also minimized by use of a properly designed weather hood if conventional filtration is to be used.

### Self-Cleaning Filters

Experience shows that self-cleaning filter cartridges can remove hoarfrost in much the same way that they clean themselves of dust. Tests



GT06807

Figure 29

have been conducted by filter vendors to simulate precipitate icing by spraying water from fog nozzles under winter conditions. These tests have demonstrated that, although ice can be built up on filters, the porosity of this ice is typically so high that the drop in filter pressure stays within acceptable limits. A frost point detector may be used to signal the selfcleaning system to begin pulsing when icing conditions are present. This helps alleviate any potential problems associated with a buildup of ice on the filters by removing it as soon as it begins to form.

The unanswered key question was whether there would be ice formation in the gas turbine inlet bellmouth due to the temperature depression which occurs there. To study *this*, extensive tests were run on an LM2500 gas turbine in western Canada during the 1981-82 winter (Fig. 29). This machine, which has a self-cleaning inlet air filter with no inlet heating, had already completed a full year of successful operation before the test.

During the test, which covered an additional 2700 fired hours of winter operation, a data logger recorded ambient and inlet temperature and humidity, pressure drop, and engine performance parameters at lo-minute intervals. In addition, time-lapse video tape recordings were made through viewing ports in the inlet plenum in order to visually identify any ice in the bellmouth. During the test period, frequent intervals of high humidity at below-freezing temperatures were recorded. Frost was visible on the inlet guide vanes for one period of less than a minute, but there was no ice build-up, and no icing problems were experienced.

Two trends can be seen which help to explain these favorable results. First, when ambient air is supersaturated with respect to ice, air downstream of the filters is found to be just at the frost point, indicating that frost is forming on the outside of the filter elements. Moisture which freezes on the filters is obviously no longer available to cause problems at the bellmouth. If too much frost builds up on the filters, it is removed by the self-cleaning action. Second, temperatures in the inlet bellmouth run about 2 to 3°F warmer than air leaving the filter compartment, even though there is no inlet heating system. This heating, which tends to counteract temperature depression, is apparently due to a combination of radiation and conduction from hot parts of the engine.

Numerous gas turbine installations now use self-cleaning filters as an anti-icing system. The self-cleaning filter has become the standard inlet filtration system at Prudhoe Bay, Alaska

because of its anti-icing capability. It has also become the favored system throughout Canada for the same reason.

## Inlet Heating Systems

Most General Electric inlet heating systems are operated by mixing hot gas from some source **with** cold, ambient air at the entrance to the inlet system. The hot gas has always been air (or air plus some combustion products); so the temperature rise can be calculated by a simple heat balance:

$$W_{\text{hot}} = W_{\text{mixed}} \frac{T_{\text{mixed}} - T_{\text{ambient}}}{T_{\text{hot}} - T_{\text{ambient}}}$$

where

w = Weight flow per unit time

T = Temperature

Early inlet heating systems included exhaust recirculation, exhaust heat recovery, and compressor bleed recirculation designs. These systems were used to prevent ice buildup both on the inlet filters and in the **ducting** and compressor. With the advent of the self-cleaning filter, and its inherent anti-icing ability, inlet heating is used today mainly in areas where compressor icing is of potential concern.

**Of** the previously mentioned inlet heating systems, only the compressor bleed system is **typically** used today. This is due to the relative simplicity of the system and its less costly effects on turbine performance.

## Compressor Bleed Inlet Heating

A compressor bleed inlet heating system uses a portion of the compressor discharge air for heating the inlet air (Fig. 30). As a result of **compressive** forces, this air typically has a temperature of 500 to 750°F, depending upon the **ambi-**

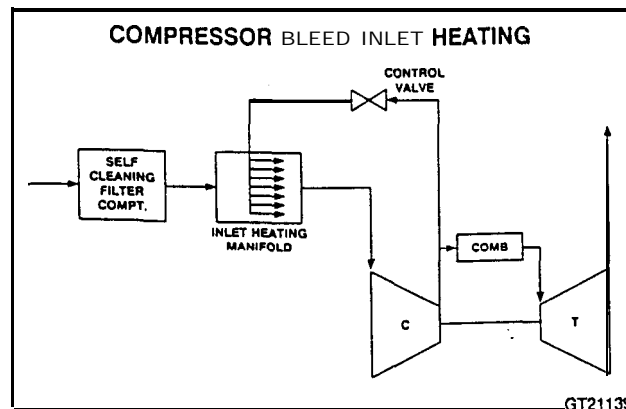

Figure 30

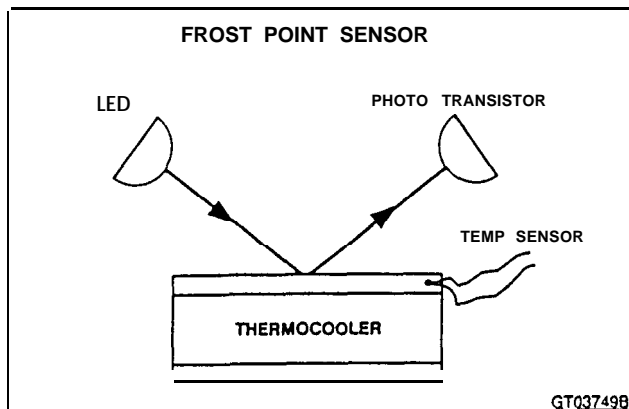

Figure 31

ent temperature and the gas turbine model. The system is basically quite simple, since only one control valve is required. Because of its simplicity, the reliability has been excellent in Alaska and Canada, as well as the North Sea.

While the compressor bleed system is simple and reliable, there is some performance degradation due to the compressor bleed requirement. This can be minimized by heating only the minimum amount necessary to keep all parts of the inlet system at a relative humidity below the frost point. This determination cannot be made on the basis of temperature alone. What is needed is a device which can measure the potential for icing, so that a control can be designed which causes the air to be heated just enough, but no more.

The key to the solution of this problem is a sensor which measures the moisture content of the air. Such a device is shown in Fig. 31. A beam from a lightemitting diode is reflected onto a phototransistor from the polished surface of an electrically cooled plate. The plate is cooled to the point where dew or frost just begins to deposit, interrupting the beam. Its temperature is measured, and the difference between this temperature and the air temperature defines the potential for condensate icing. This device measures absolute humidity, avoiding the problems inherent in relative humidity sensors and lending itself well to optional inclusion in a control system.

## Recommendations

Good experience with self-cleaning filters for both inlet air filtration and anti-icing has made it the standard system in environments with a high icing potential. There is no question that self-cleaning filters provide very high air quality; thousands of hours of desert operation have demonstrated this conclusively. As a means of

anti-icing, the simplicity of the concept and its minimal effect on performance make it particularly attractive to the user. For applications where supplemental inlet heating is required to prevent icing in the compressor bellmouth, compressor bleed inlet heating is recommended. This is based on a balance of cost, reliability, and impact on performance.

## INLET COOLING SYSTEMS

### Introduction

An inlet cooling system is a useful gas turbine option for applications where significant operation occurs in the warm months and where low relative humidities are common. The cooled air, being denser, gives the machine a higher mass-flow rate and pressure ratio, resulting in an increase in turbine output and efficiency. This is a cost-effective way to add machine capacity during the period when peaking power periods are usually encountered on electric utility systems.

There are two basic systems currently available for inlet cooling. First, and perhaps the most widely accepted system is the evaporative cooler. Evaporative coolers make use of the evaporation of water to affect a reduction in inlet air temperature. Another system currently being studied is the inlet chiller. This system is basically a heat exchanger through which the cooling medium (usually chilled water) flows and removes heat from the inlet air thereby reducing the inlet temperature and increasing gas turbine output.

In addition to the obvious advantage of achieving extra power, the use of an evaporative cooler improves the environmental impact of the machine. Increasing water vapor in the inlet air tends to lower the amount of oxides of nitrogen produced in the combustion process and, therefore, lowers the emissions of the machine.

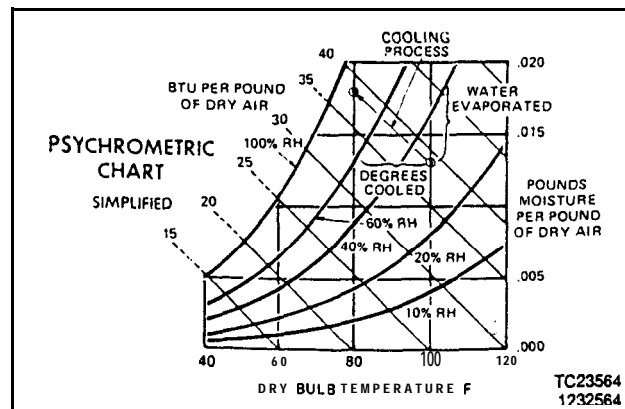

Figure 32

## Evaporative Cooler Theory

The actual temperature drop realized is a function of both the equipment design and atmospheric conditions. The design controls the effectiveness of the cooler, defined as follows:

$$\text{Cooler effectiveness} = \frac{T_{1DB} - T_{2WB}}{T_{1DB} - T_{2WB}}$$

Subscript 1 refers to entering conditions and 2 to the exit; DB means dry-bulb temperature and WB means wet-bulb. The effectiveness of General Electric evaporative coolers is typically 85 percent; so the temperature drop can be calculated by:

$$\Delta T_{DB} = 0.85 (T_{1DB} - T_{1WB})$$

As an example, assume that the ambient temperature is 100°F and the relative humidity is 32 percent. Referring to Fig. 32, which is a simplified psychrometric chart, the corresponding wet-bulb temperature is 75°F. The temperature drop through the cooler is then 0.85 (100-75), or 21°F. The cooling process follows a line of constant enthalpy as sensible heat is traded for latent heat by evaporation.

The current self-cleaning filter/evaporative cooler design is shown in Fig. 33. Water is pumped from a tank at the bottom of the module to a header which distributes it over the media blocks. These are made of corrugated layers of fibrous material, with internal channels formed between layers. There are two alternating sets of channels, one for water and one for air. This separation of flows is the key to reducing carry-over. However it is standard practice at General Electric to provide a stage of drift eliminators downstream of the media to protect against the possibility of water carry-over. The water flows down by gravity through the water

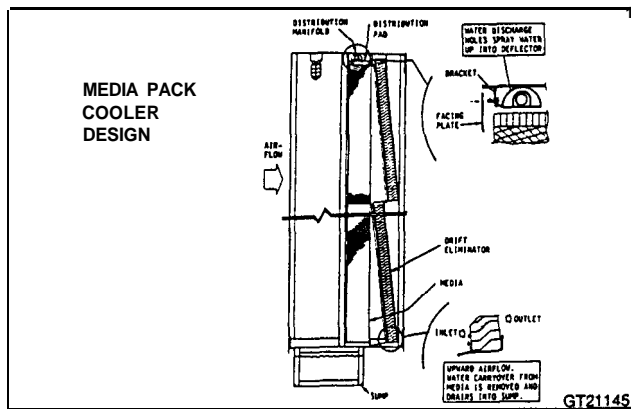

Figure 33

channels, and diffuses throughout the media by wicking action. Any excess returns to the tank. The level of water in the tank is maintained by a float valve which admits make-up water.

The ambient temperature setpoint (located at the cooler controller) is adjustable. It is factory preset to allow cooler operation at ambients above the setpoint, which must be 60°F or higher. If evaporation were permitted at too low a temperature, there would be a possibility of causing icing which is of course to be avoided. When there is a possibility that the dry-bulb temperature will fall below freezing, the whole system must be deactivated and drained to avoid damage to the tank and piping, and to avoid the possibility that the porous media would plug with ice.

## Water Requirements

Evaporative coolers find their greatest application in arid regions. In such areas it is not uncommon to find that available water has a significant percentage of dissolved solids. If make-up water is only added in sufficient quantity to replace the water which has been evaporated, it is obvious that the water in the tank (which is also the water pumped to the media for evaporation) must gradually become more laden with minerals. In time, these will tend to precipitate out on the media and reduce evaporation efficiency, and the hazard increases that some minerals will become entrained in the air and enter the gas turbine. In order to minimize this it is usual to continually bleed some water from the tank to keep the mineral content diluted. This is termed blowdown.

The total amount of water which must be provided as make-up is the sum of evaporation and blowdown. The rate at which water evaporates from a cooler depends upon the ambient temperature and humidity, the altitude, cooler effectiveness, and the airflow requirement of the gas turbine. The

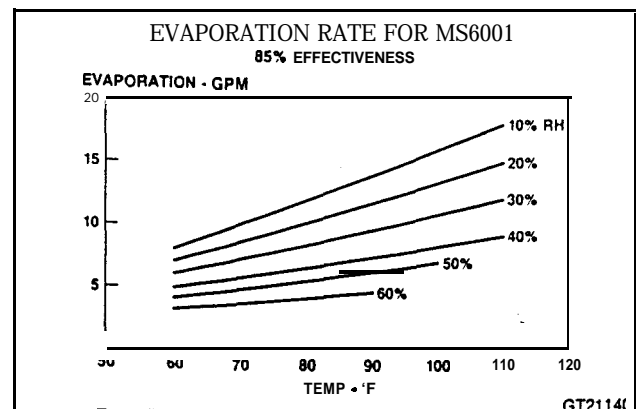

Figure 34

evaporative requirement of an 85 percent effective MS8001 gas turbine cooler at sea-level is shown in Fig. 34. The corresponding value for an MS7001 or MS9001 machine may be estimated by respectively doubling or tripling the quantity shown.

One of the main concerns in determining the acceptability of water quality is its propensity to deposit scale. Scaling is influenced by the interaction of the water's total hardness, total alkalinity (ALK), total dissolved solids (TDS), pH and water temperature. To assist in determining whether the available water is suitable for use in General Electric evaporative coolers, a saturation index (SI) is used.

A standard laboratory analysis of the water can determine the total hardness (ppm as CaCO<sub>3</sub>), total alkalinity (ppm as CaCO<sub>3</sub>), total dissolved solids (ppm) and pH. The levels of the first three components are first modified by an adjustment factor W:

$$W = (\frac{1}{B} + 1) (\frac{1}{F} + 1)$$

where

$$F = \text{flood factor} = \frac{\text{water drain rate from media to tan}}{\text{water evaporation rate}}$$

$$B = \text{blowdown factor} = \frac{\text{water bleed rate from tank}}{\text{water evaporation rate}}$$

Water evaporation rate can be estimated from Fig. 34.

For most cases F and B are adjusted during installation to be approximately uniform on a typical hot day so  $W = 4$ . However, to make low-quality water more suitable, an increased blowdown rate may be used to lower the adjustment factor. Flood factor should not be adjusted to compensate for water quality since this could result in liquid water carry-over.

The ppm of TDS, ALK, and hardness are multiplied by the adjustment factor to obtain ppm (adjusted). To evaluate the suitability of water for General Electric evaporative coolers, a **modified**

**Langlier** saturation index chart is used (see Fig. 35). The adjusted total alkalinity (ppm as CaCO<sub>3</sub>) is converted to **PALK**, and the adjusted total hardness (ppm as CaCO<sub>3</sub>) is converted to **PCa** by entering the chart on the righthand ordinate and reading the appropriate quantity from the righthand abscissa. The adjusted total dissolved solids are converted to **PTDS** by entering the left ordinate, selecting the appropriate water temperature (which may be taken to be the wet bulb temperature), and reading the upper left abscissa.

$$\text{Saturation Index (SI)} = \text{pH} - \text{PCA} - \text{PALK} - \text{PTDS}$$

SI < 1.0 indicates no water treatment is required.

Water treatment may be used to control any property or combination of properties to reduce SI to 1.0 or less. Initially, the **blowdown** rate is adjusted to be approximately the same as the evaporation rate on a typical hot day; this may later be adjusted based on operational experience and local water quality.

Despite care with water quality, the media will eventually have to be replaced as material precipitates out in sufficient quantity to impair its effectiveness. However, experience indicates that this may take quite a long time. At one site there has been operation for six seasons under very adverse conditions with insignificant performance **degradation**. It is expected that the media will continue to be used for at least two more years. While this is believed typical, the estimate is subject to **change** as more experience is gained.

Tests indicate that the feedwater may have high levels of sodium and potassium without significant carry-over of these metals into the gas turbine. However, very careful attention to detail is necessary in order to realize this level of performance. This includes proper orientation of the media packs, correct flows of air and water, uniform distribution of water over the media surface, and proper drainage back to the tank. Any deficiencies in these areas may make it possible for water to become entrained in the air, with potentially serious results. Consequently, installation **and** maintenance of evaporative cooling equipment is very important. In areas where the water exceeds 133 ppm sodium and potassium it is good practice to **periodically** check the rate at which these elements enter the gas turbine by means of a **mass-balance** calculation. Any discrepancy between the rate at which sodium and potassium enter in the

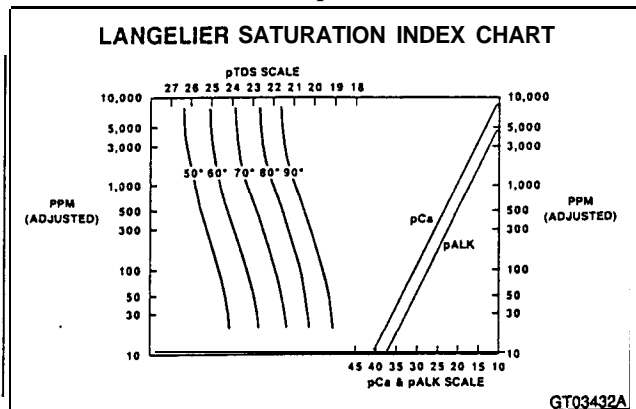

Figure 35

feedwater and the rate at which they leave in the **blowdown** can be attributed to carry-over. It will be recalled that the concentration of these elements in the inlet air should typically be held to 0.005 ppm or less; this is equivalent to an ingestion rate of 0.01 lb./h. for an MS7001 gas turbine, 0.005 lb./h. for an MS5000, and 0.0002 lb./h. for an MS3002.

### Operational Experience

When medium-type coolers were first placed in service, some units exhibited unacceptable carry-over. It was found that this problem had three possible causes: damaged or improperly installed media, entrainment of water from the distribution manifold, or local areas of excessive velocity through the media. The first cause was removed by new procedures for shipping and installing the media blocks. Carry-over from the manifold was eliminated by installation of blanking plates downstream of the spray elements. The third problem, high flow velocity through portions of the media, was the most difficult to solve. After considerable effort, two solutions were developed. The first incorporated features in the design to force more uniform flow, so that velocities everywhere were within the acceptable range. The second solution was more radical. It involved a new design which accepted some carry-over from the media, but which eliminated carry-over into the gas turbine by use of eliminator blades (similar to the vanes of a moisture separator) immediately downstream of the evaporative media. Both approaches have proven successful in the field and both approaches are now taken together to ensure no water carry-over. There has been no problem in meeting goals for cooler effectiveness in any of the more than 75 media-type coolers now in the field.

### Inlet Cooling Coils

As with the evaporative cooler, the actual temperature reduction from a cooling coil is a function of equipment design and ambient conditions. Unlike the evaporative cooler, however, cooling coils are able to lower the inlet dry bulb temperature below the ambient wet bulb temperature. The actual temperature reduction is limited only by the capacity of the chilling device, the **effectiveness** of the coils, and the acceptable temperature/humidity limits of the compressor.

Figure 36 shows a typical cooling cycle based on an ambient dry bulb temperature of **100°F** and **20** percent relative humidity. Initial cooling follows a line of constant humidity ratio. As the air approaches saturation, moisture begins to condense out of the air. If the air is cooled further, more moisture condenses. Once the temperature reaches this regime, more and more of the heat removed from the air is used to condense the water. This leaves less capacity for temperature reduction. Because of the potential for water condensation, General Electric recommends that drift eliminators be installed downstream of the coils to prevent excessive water ingestion by the gas turbine. The exact point at which further cooling is no longer feasible depends upon the desired gas turbine output and the capacity of the chilling system.

It is readily apparent in Fig. 36 that the air can easily be cooled below the ambient wet bulb temperature. Therein lies one of the major benefits of the cooling coil system. It must be pointed out, though, that the lower limit of cooler operation is a compressor inlet temperature of **45°F** with a relative humidity of 95 percent. At temperatures below **45°F** with such high relative humidity, icing of the compressor is probable.

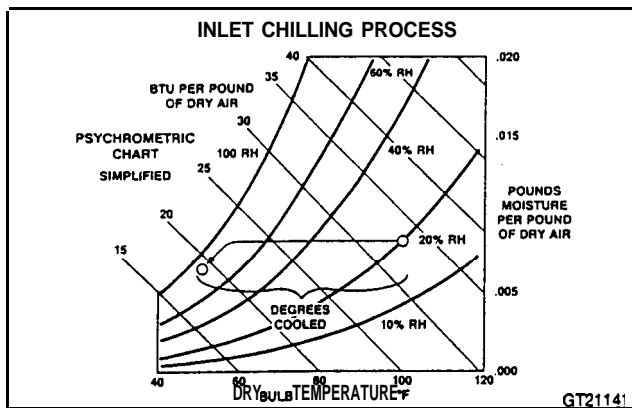

Figure 36

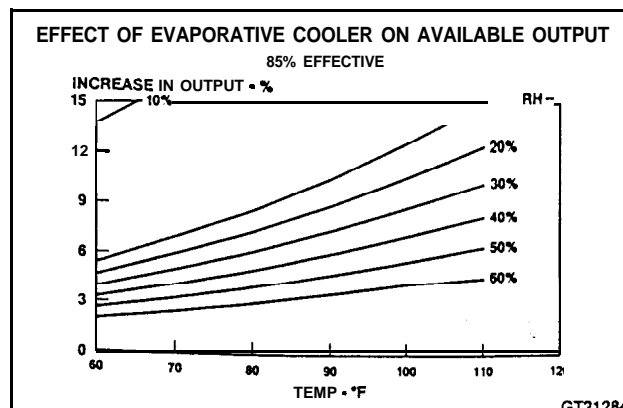

Figure 37

## Power Increase

The exact increase in power available from a particular gas turbine as a result of inlet air cooling depends upon the machine model and site altitude as well as ambient temperature and humidity. However, Fig. 37 can be used to make an estimate of this benefit for evaporative coolers. As would be anticipated, the improvement is greatest in hot, dry weather. The power increase from a cooling coil is also dependent upon the chiller capacity so it is difficult to make a general estimation. The addition of an inlet cooler is economically viable when the value of the increased output exceeds the initial and operating costs, and appropriate climatic conditions permit effective utilization of the equipment.

## SUMMARY

It has been shown that there are many environments which are naturally hostile to gas turbine operation, but that General Electric has developed a wide range of inlet air treatment equipment which permits its machines to adapt to these conditions and operate successfully. With the information given in this paper, it is hoped that gas turbine users will be able to identify potential needs for air treatment, and to knowledgeably consider equipment options. General Electric applications engineers have many years of experience in this field and are ready to assist in selection of suitably equipped inlet compartments to enhance gas turbine performance, reliability, and maintainability.

## REFERENCES

1. **Beltran**, A.M., and **Shores**, D.A., "Hot Corrosion," Chapter 11 from *Superalloys*, C.T. Sims and W.C. **Hagel**, eds., John Wiley and Sons, 1972.
2. **Fairman**, L., "Mechanism of Accelerated Oxidation by Vanadium-Containing Fuel Ash," *Corrosion Science*, Vol. 2 1962, pp. 293-296.
3. **Bradury**, B.J. **Hancock**, P., and **Lewis** H., "The Corrosion of Nickel-Base Material in Gas Turbine and Boiler Atmospheres," *Metallurgia*, January 1963. pp. 3-14.
4. "Air Quality Data-1978 Annual Statistics," EPA-450/4-79-037, U.S. Environmental Protection Agency, Research Triangle Park, North Carolina.
5. **Artificial Stimulation of Rain**, Geophysics Research Directorate, Air Force Cambridge Research Center and Geophysics Branch, Office of Naval Research, Pergamon Press, NY, 1957, p. 163.
6. **Anderson**, A.W. and **Neaman**, R.G., "Field Experience with Pulse-Jet Self-Cleaning Air Filtration on Gas Turbines in a Desert Environment," *ASME Paper 82-GT-283*.
7. **Tatge**, R.B., **Gordon**, C.R., and **Conkey**, R.S., "Gas Turbine Inlet Air Filtration in Marine Environments-Part I: Marine Aerosols and Equipment for Their Control," *ASME Paper 80-GT-174*.
8. **Krulls**, G.E. and **Lastella**, J., "Gas Turbine Salt Ingestion Analysis." *ASME Paper 77-GT-20*.
9. **Toba**, Y., "On the Giant Sea-Salt Particles in the Atmosphere," *Tellus*, Vol. 17, No. 1, 1965, pp. 131-145.
10. **Randles**, R.H. and **Ansari**, F., "Evaluation of the Peerless Mark 1 Spray Eliminator for Protection of Marine Gas Turbine Air Intakes," Naval Marine Wing Note No. 30/71, National Gas Turbine Establishment, Pyestock, Hants, England.
11. **Jungle**, C.E., ed., "Aerosols," *Air Chemistry and Radioactivity*, Academic Press, 1963, pp. 111-208.
12. **Tatge**, R.B., **Gordon**, C.R., and **Conkey**, R.S., "Gas Turbine Inlet Air Filtration in Marine Environments-Part II: Commercial Experience and Recommended Practice," *ASME Paper 80-GT-175*.
13. **Chappell**, M.S. *Stationary Gas Turbine Icing Problems: The Icing Environment*, National Research Council, Ottawa, Canada, January 1973.
14. **Appelman**, H., "The Cause and Forecasting of Ice Fogs," *Bull. Am. Meteorological Soc.*, Vol. 34, No. 9, November 1953.
15. **Grabe**, W. and **Chappell**, M.S. *Stationary Gas Turbine Icing Some Design Guidelines for Blowing Snow Environments*, National Research Council, Ottawa, Canada, September 1974.



## CONVERSION FACTORS

The following is a list of **conversion** factors most commonly used for gas turbine performance.

To	Convert	To	Multiply By	To	Convert	To	Multiply By
acres		hectares	$4.047 \times 10^{-1}$	hp (U.S.)		hp (metric)	1.014
atm		kg/cm <sup>2</sup>	1.0333	in.		cm	2.540
atm		lb/in. <sup>2</sup>	$1.47 \times 10^{-1}$	in.		mm	$2.54 \times 10^{-1}$
bars		atm	$9.869 \times 10^{-1}$	in. <sup>2</sup>		mm <sup>2</sup>	$6.452 \times 10^2$
bars		lb/in.*	$1.45 \times 10^1$	in. of mercury		kg/cm <sup>2</sup>	$3.453 \times 10^{-2}$
Btu		J (joules)	$1.055 \times 10^3$	in. of water (at 4°C)		kg/cm <sup>2</sup>	$2.54 \times 10^{-3}$
Btu		kcal	$2.52 \times 10^{-1}$	in. of water (at 4°C)		lb/in. <sup>2</sup>	$3.613 \times 10^{-2}$
Btu/h		kcal/h	$2.520 \times 10^{-1}$	J		Btu	$9.486 \times 10^{-4}$
Btu/h		kJ/h	1.0548	kg		lb	2.2046
Btu/h		W (watts)	$2.931 \times 10^{-1}$	kg/cm <sup>2</sup>		lb/in.*	$1.422 \times 10^1$
Btu/hp-h		kcal/kWh	$3.379 \times 10^{-1}$	kg-m		ft-lb	7.233
Btu/hp-h		kJ/kWh	1.4148	kg/m <sup>3</sup>		lb/ft <sup>3</sup>	$6.243 \times 10^{-2}$
Btu/kWh		kcal/kWh	$2.5198 \times 10^{-1}$	km		miles (statute)	$6.214 \times 10^{-3}$
Btu/kWh		kJ/kWh	1.0548	kW		hp	1.341
Btu/lb		kcal/kg	$5.555 \times 10^{-1}$	l		ft <sup>3</sup>	$3.531 \times 10^{-2}$
Btu/lb		kJ/kg	2.3256	lb		kg	$4.536 \times 10^{-1}$
°C		°F	$(°C \times 9/5) + 32$	lb/in. <sup>2</sup>		kg/cm <sup>2</sup>	$7.03 \times 10^{-2}$
°C		K	$°C + 273.15$	lb/in.*		Pa	$6.8948 \times 10^3$
cm <sup>3</sup>		ft <sup>3</sup>	$3.531 \times 10^{-5}$	lb-ft <sup>2</sup>		kg-m <sup>2</sup>	$4.214 \times 10^{-1}$
cm <sup>3</sup>		in. <sup>3</sup>	$6.102 \times 10^{-2}$	l/min		ft <sup>3</sup> /s	$5.886 \times 10^{-4}$
°F		°C	$(°F - 32) \times 5/9$	l/min		galls	$4.403 \times 10^{-3}$
ft		m	$3.048 \times 10^{-1}$	m		ft	3.281
ft <sup>2</sup>		m <sup>2</sup>	$9.29 \times 10^{-2}$	m <sup>2</sup>		ft <sup>2</sup>	$1.076 \times 10^1$
ft <sup>3</sup>		l (liters)	$2.832 \times 10^1$	m <sup>3</sup>		ft <sup>3</sup>	$3.531 \times 10^1$
ft <sup>3</sup>		m <sup>3</sup>	$2.832 \times 10^{-2}$	mile (statute)		km	1.6093
ft-lb		Btu	$1.286 \times 10^{-3}$	tons (metric)		kg	$1.0 \times 10^3$
ft-lb		kg-m	$1.383 \times 10^{-1}$	tons (metric).		lb	$2.205 \times 10^3$
ftlmin		km/h	$1.8288 \times 10^{-2}$	W		Btu/h	3.4129
ft <sup>3</sup> /min		l/s	$4.720 \times 10^{-1}$	W		Btu/min	$5.688 \times 10^{-2}$
ft <sup>3</sup> /min		m <sup>3</sup> /min	$2.832 \times 10^{-2}$	W		ft-lb/s	$7.378 \times 10^{-1}$
gal		m <sup>3</sup>	$3.785 \times 10^{-3}$	W		hp	$1.341 \times 10^{-3}$
gal/min		l/s	$6.308 \times 10^{-2}$				
hectares		acres	2.471				
hp (U.S.)		kW	$7.457 \times 10^{-1}$				

*For further information, contact your GE Field  
Representative or write to GE Communication Programs*



*GE Industrial &  
**Power Systems***

---

*General Electric Company  
Building 2, Room 115B  
One River Road  
Schenectady, NY 12345*